

Figure 2

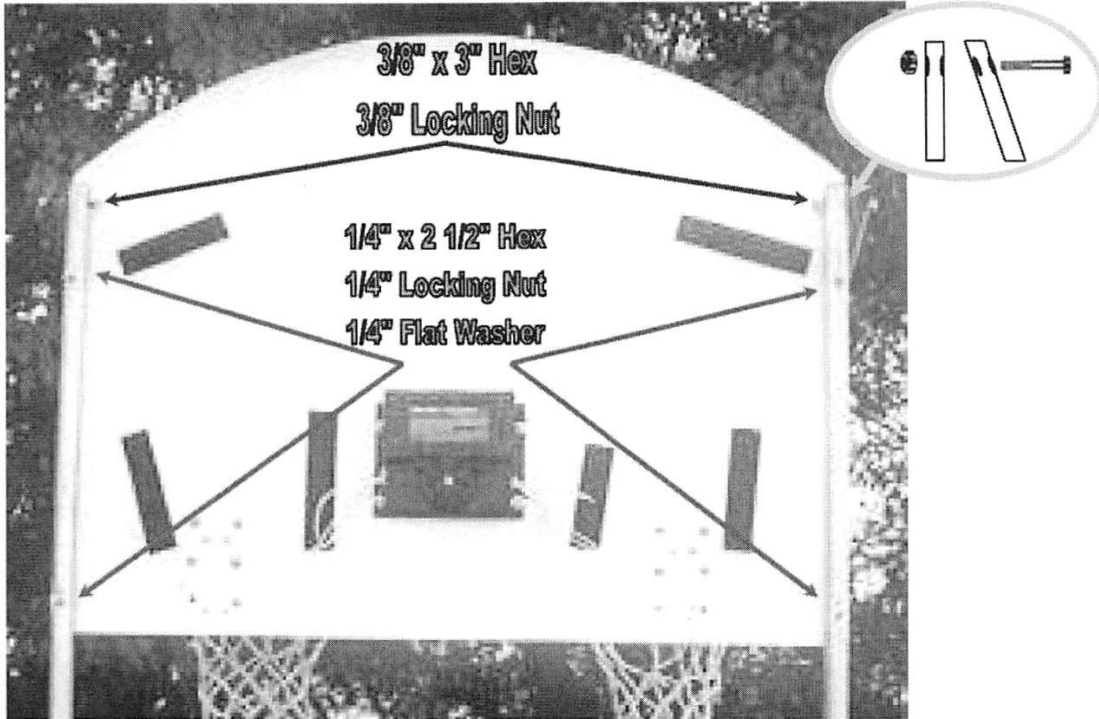

Figure 3

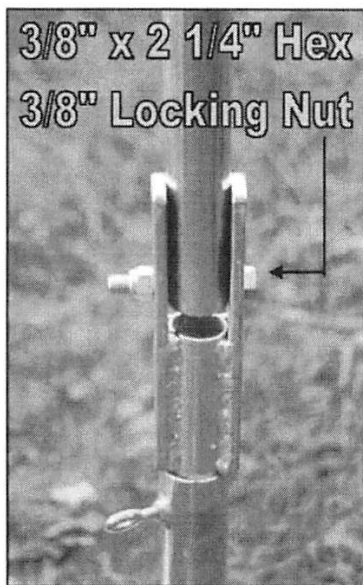

Figure 4

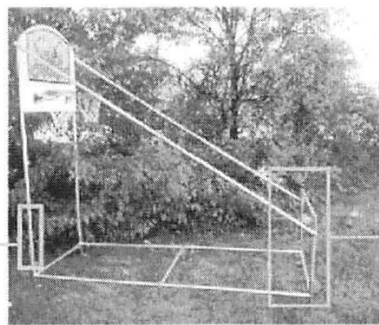

Figure 5

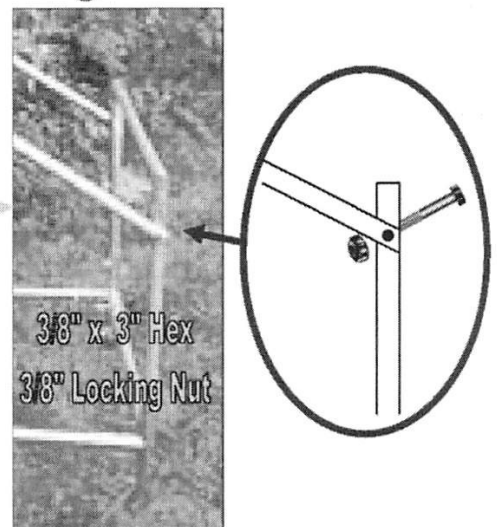

Figure 6

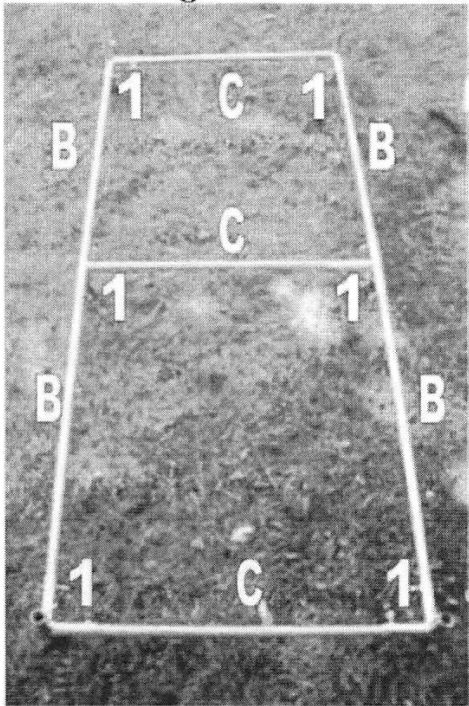

Figure 7

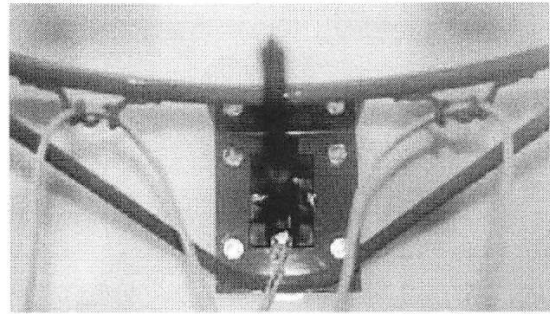
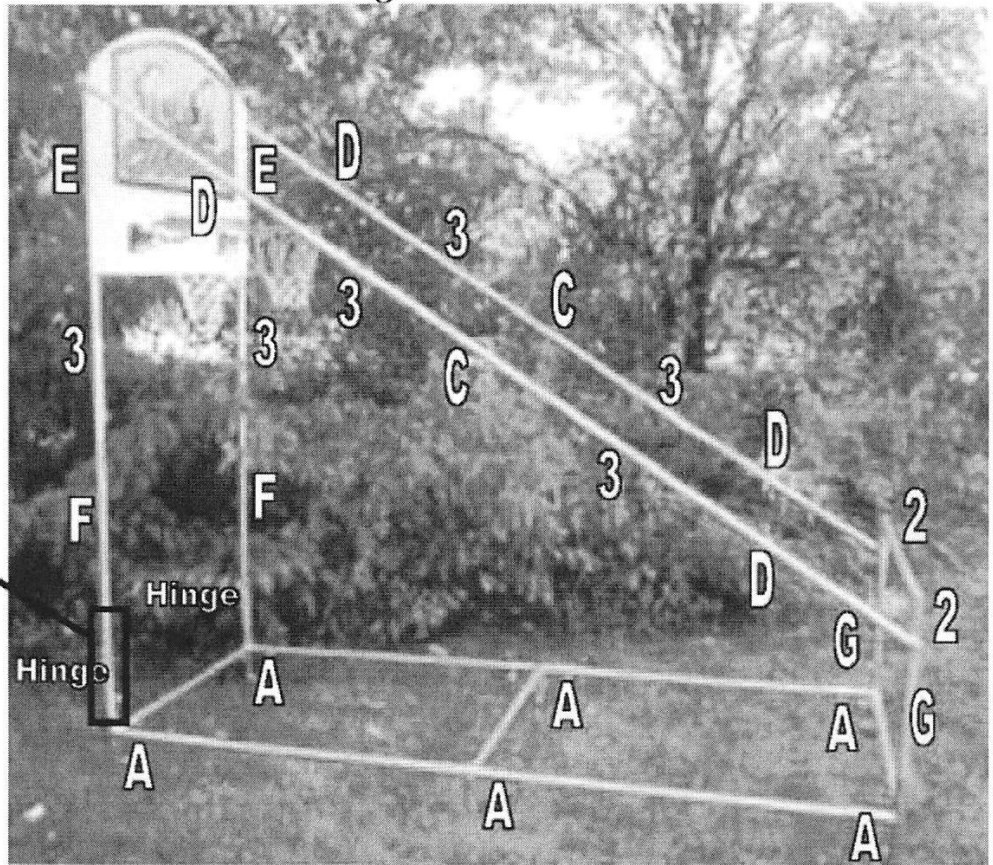
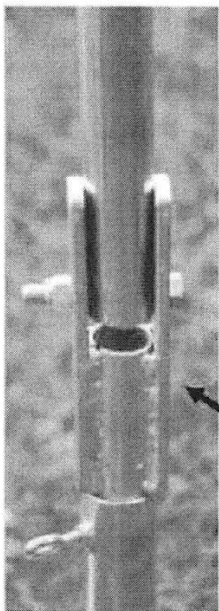

Figure 9

Figure 8



NOTE: Identify all pipes and fittings before beginning assembly. Use both the Part Drawings and Descriptions to correctly identify the parts.

1. Attach a *Pipe E* to either side of the *Backboard* using four $1/4$ " x $2 1/2$ " *Hex Bolts*, and four $1/4$ " *Washers*, and four $1/4$ " *Locking-Nuts*. (Figure 2)

Line up the holes in the pipe with the holes on either side of the backboard. Put a bolt through each hole on either side of the front of the backboard and put the bolts through the holes in pipe E. Then add a washer and a nut to each bolt on the back of the unit. Tighten each.

2. Attach the *Rim* to the *Backboard* using four $1/4$ " x $1 1/4$ " *Hex Bolts* and four $1/4$ " *Locking Nuts*. (Figure 7)

Put the four bolts through the holes in the rim bracket, then put them through the four holes in the backboard. Put a washer and a locking nut on each of the bolts on the back of the unit. Repeat this process for the second rim.

3. Attach the *Score Keeper Levers* to the center of the *Rim Plate* using two $10-24$ x $1 1/2$ " *FlatHead Bolts*, two $10-24$ *Flat Washers*, and two $10-24$ *Locking Nuts*. (Figure 7)

Put the bolts through the holes in the score keeper lever and then through the holes in the center of the rim plate and the backboard. On the back, add a flat washer and a locking nut to each bolt. Repeat this process on the second rim.

4. Attach the *Nets* to the *Rims*.

5. Attach *Score Keeper Unit* and *Display Lens* to backboard using four $10-24$ x $1 1/2$ " *FlatHead Bolts*, four #10 *Flat-Washers*, and four $10-24$ *Locking-Nuts*.

Put the bolts through the holes in the score keeper (the bottom bolts need to go through the holes in the red display lens first), then through the backboard. Add a flat washer and a locking-nut to each of the bolts on the back of the unit.

6. Plug the two *Score Keeper Wires* into the sides of the *Score Keeper Unit*. Also, plug in the *A/C Adapter* if you are running it off AC power.

7. Put a *Rubber Tip* on one end of each length of *Pipe A*.

8. Assemble framework according to the following pictures.

9. Attach the *Ramp/Side Net* using the *Velcro Flaps*.

10. Inflate balls. Note--leave the balls slightly under-inflated in order to keep them from bouncing out of the unit.

Figure 1

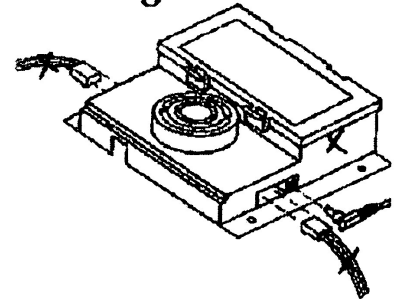

NOTE: If you know that you will not want to take the unit apart, you may want to consider *tack welding* the fittings to the pipes. That way, the frame will not come apart during transport.

Packing List

<i>Part</i>	<i>Quantity</i>
A Pipes	6
B Pipes	4
C Pipes	6
D Pipes	4
E Pipes	2
F Pipes	2
G Pipes	2
#1 Fittings	6
#2 Fittings	2
#3 Fittings	6
Hinges	2
3/8" x 3" Hex Head Bolt	4
3/8" x 2 1/4" Hex Head Bolt	2
1/4" x 2 1/2" Hex Head Bolt	4
1/4" x 1 1/4" Hex Head Bolt	8
10-24 x 1 1/2" Roundhead Slotted Bolt	8
3/8" Locking Nut	6
1/4" Locking Nut	12
10-24 Locking Nut	8
1/4" Flat Washer	12
10-24 Flat Washer	4
Backboard	1
Mini-Basketballs	6
Rims	2
Nets	2
Ball Ramp	1
Score Keeper Unit	1
Score Keeper Levers	2
A/C Adaptor	1
Rubber Tips	6
Needle Valve	1

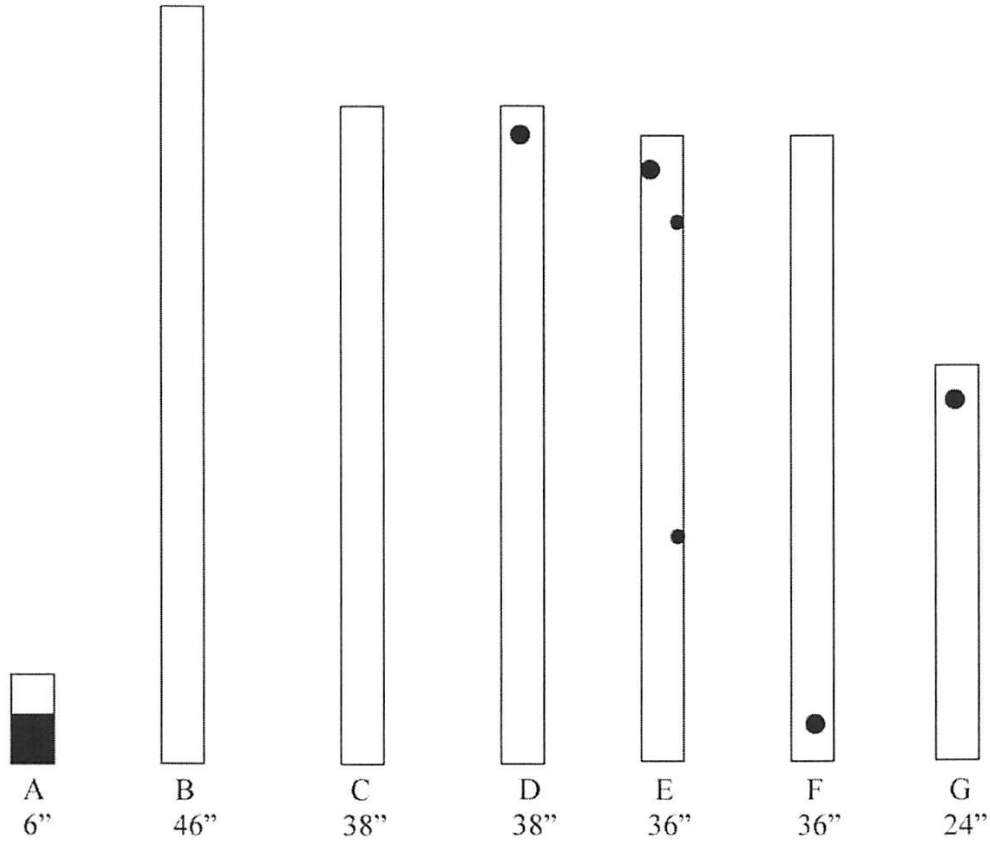

3/8" x 3" Hex Bolts

3/8" Locking Nut



3/8" x 2 1/4" Hex Bolts



1/4" Locking Nut

1/4" x 2 1/2" Hex Bolts

10-24 Locking Nut

1/4" x 1 1/4" Hex Bolts

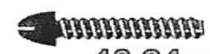
1/4" Flat Washer

10-24 x 1 1/2"
Roundhead Slotted Bolts

10-24 Flat Washer

Score Keeper Trouble Shooting

Problem	Possible Cause	Solution
No display or sound when a shot is made.	Batteries are not installed properly or the batteries are bad.	Reinstall new batteries: be sure they make good contact with the battery holder.
Display but no sound.	Volume control turned all the way down.	Adjust the volume control with the knob on the side of the score keeper.
The ball passes through the basket but a point is not scored.	Bad switch connection.	Check the connections between the switches and the score keeper.
The score keeper resets during play.	1. Weak batteries. 2. Throwing the ball excessively hard against backboard can jar batteries loose.	1. Replace the batteries. 2. Do not throw the ball hard as this may damage the system.
Players receive static shock from the unit during play.	Static electricity build-up on the ball due to extremely dry atmospheric conditions.	Spray ramp with anti-static solution (a 50% mixture of fabric softener & water will work.)
"LO bA" appears.	Weak batteries.	Install new batteries.



Hayes Specialties Corporation

1761 East Genesee Avenue Saginaw, MI 48601
(989) 755-6541 (800) 248-3603

www.eHayes.com

TOYS NOVELTIES POPCORN